

Help at Home

Parent Booklet

Maths NI
Improvement



Key Stage 1

Table of Contents

Short description	Page no
Targets & Strategies	03
50 Grid Un-numbered	04
50 Grid Numbered	05
100 Square Un-numbered	06
100 Square Numbered	07
Counting On/Back	08
Higher Level Combining	09
Higher Level Partitioning	10
Rounding & Adjusting Strategy	11
What Strategy is Best?	14
Subtraction	15
Addition	23
Place Value	26
Useful Websites/Links	29

Targets & Strategies

During KS1 your child may be working towards achieving and being competent in the following areas:

- Count to 1000 and be able to recognise, read or write any 3-digit number
- Count in tens. E.g. 36, 46, 56, 66, 76, 86, 96, 106, 116 ...
- Know the pairs of numbers which make ten. E.g. 4+6, 7+3, 5+5 ...
- Add 2 single digit numbers bridging 10 e.g. 6+8
- Add two numbers by counting on the tens and then counting on the units. E.g. 46+23
- Add a string of small numbers. E.g. 6+4+7+2+6
- Add 10, 20 or 30 or 40 to a number. E.g. 94+20
- Subtract one number from another when the numbers are close. E.g. 43-37
- Subtract one number from another when the numbers are not close. E.g. 54-9
- Know the 2x, 3x, 5x, 9x and 10x tables (if necessary, using fingers fast!)
- Recognise dividing as the opposite of multiplying. E.g. 27/3 means 'How many 3's in 27?'
- Recognised odd and even numbers
- Double numbers up to 20 and halve even numbers up to 40
- Add/Subtract 1,2, 0 to any number, answers within 100
- Add/Subtract 10 to/from a 2-digit number, answers within 100
- Subtract a single digit from 20
- Add a single digit to a 2 digit number without bridging 10 (54+3)
- Subtract a single digit from a number within 20, without bridging 10 (17-4)
- Subtract a single digit from a 2-digit number without bridging 10 (56-4)
- Know position of tens digit indicates its value
- Know all single digit subtraction facts within 10
- Find what must be added to a number to make 20
- Find what must be added to a multiple of 10 to make 100 (60+?=100)
- Find what must be added to any 2 digit number to make the next highest multiple of 10 (33+?=40)
- Find what must be subtracted from any 2 digit number to make the next lower multiple of 10 (47-?=40)
- Add/subtract a multiple of 10 to/from a multiple of 10, answers within 100 (30+40, 60-20)
- Add/subtract 9, 11 to/from any 2 digit number, answers within 100
- Add/subtract a multiple of 10 to/from any 2 digit number, answers within 100 (o) (34 + 50, 89-40)
- Use to add/subtract 21, 31, 19, 29 etc to/from any 2 digit number, answers within 100 (47+29, 53-19)
- Know position of hundreds digit indicates its value
- Understand zero as a place holder
- Know multiplication facts for 1x, 2x, 5x, 10x tables

50 Grid (Un-Numbered)



50 Grid Numbered

1	2	3	4	5	6	7	8	9	10
11	12	13	14	15	16	17	18	19	20
21	22	23	24	25	26	27	28	29	30
31	32	33	34	35	36	37	38	39	40
41	42	43	44	45	46	47	48	49	50

100 Square (Un-Numbered)

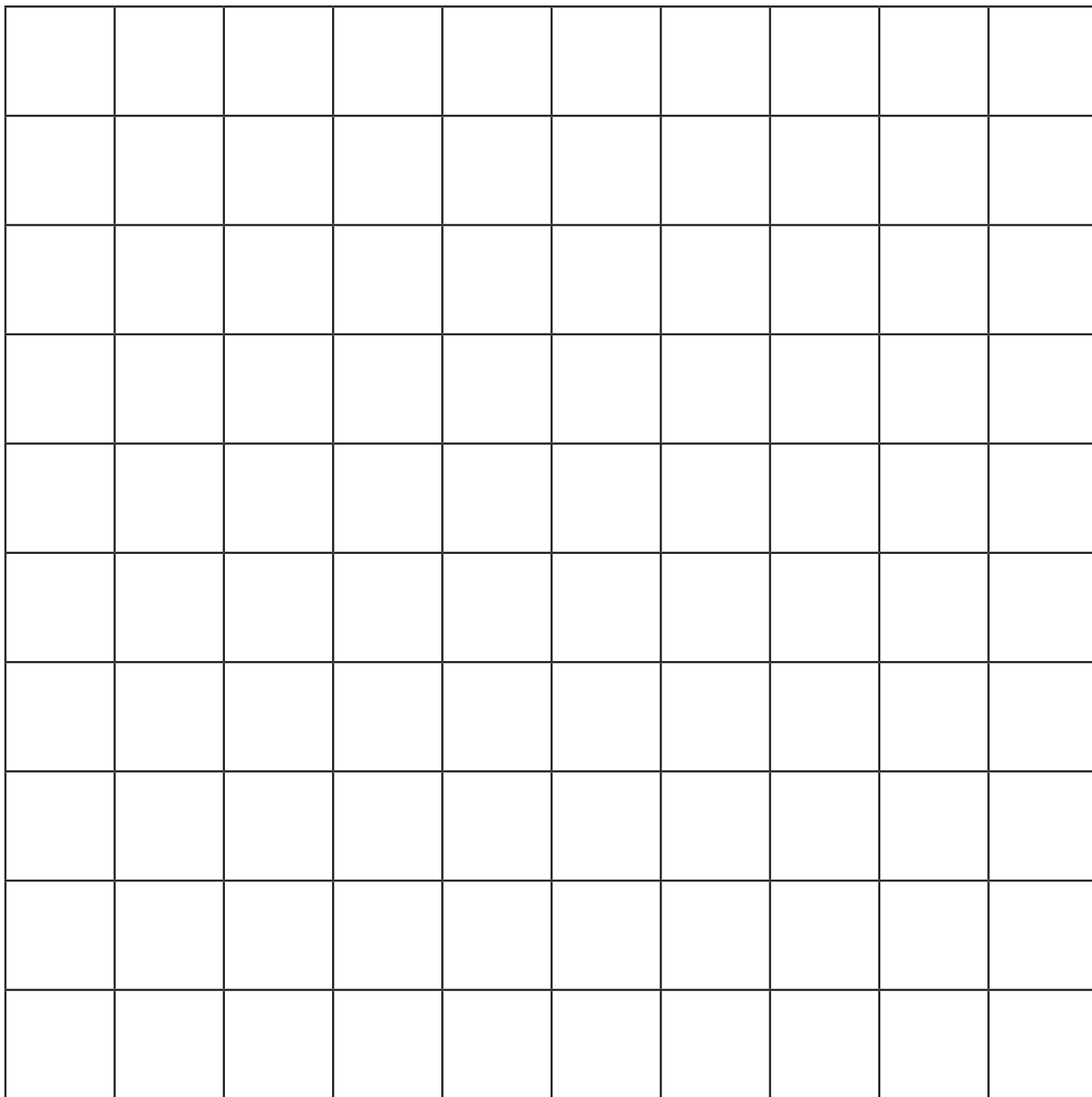

100 Square (Numbered)

1	2	3	4	5	6	7	8	9	10
11	12	13	14	15	16	17	18	19	20
21	22	23	24	25	26	27	28	29	30
31	32	33	34	35	36	37	38	39	40
41	42	43	44	45	46	47	48	49	50
51	52	53	54	55	56	57	58	59	60
61	62	63	64	65	66	67	68	69	70
71	72	73	74	75	76	77	78	79	80
81	82	83	84	85	86	87	88	89	90
91	92	93	94	95	96	97	98	99	100

Counting On/Back using empty number line

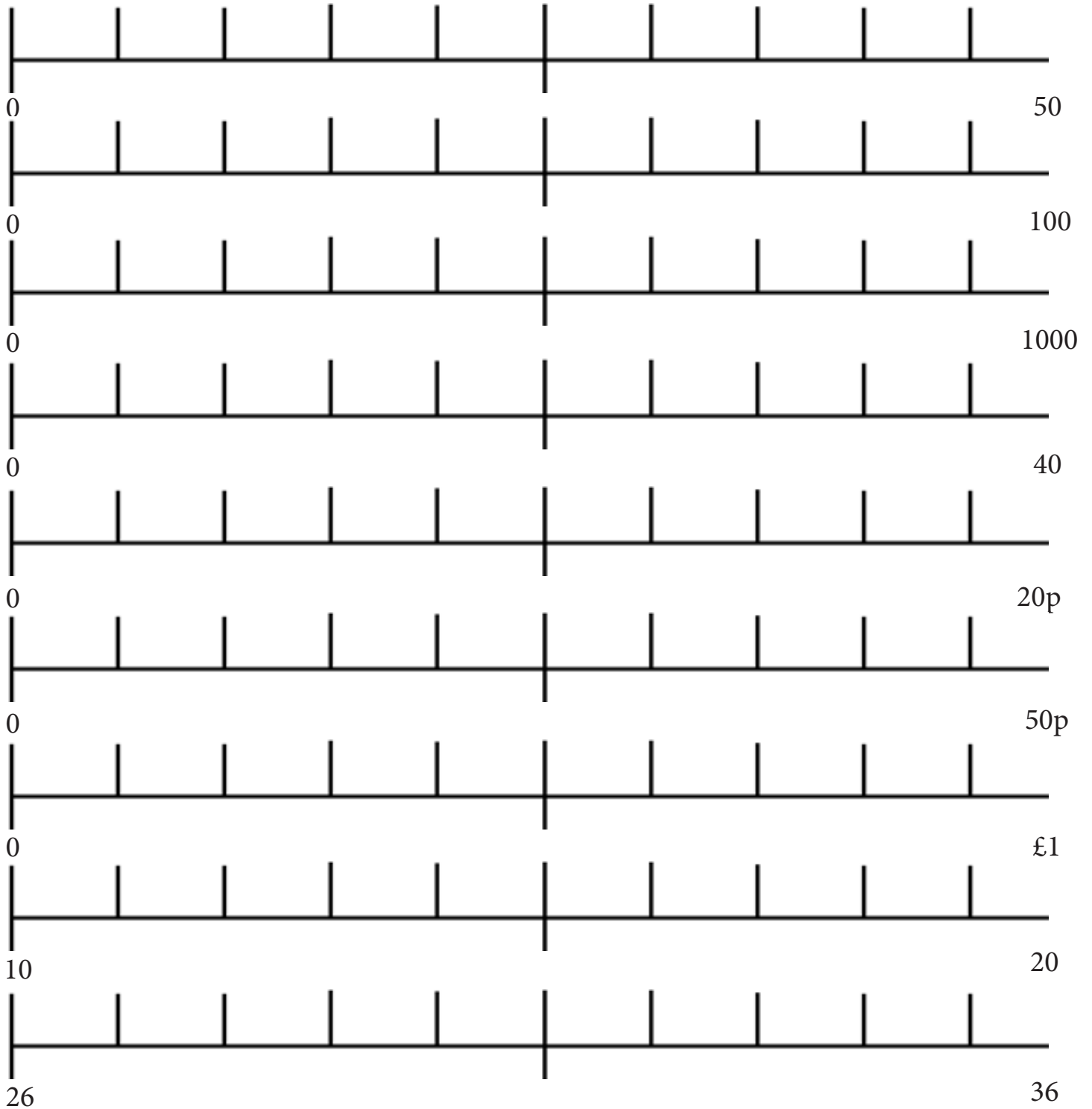

Typical Questions to ask your child:

1. What number is this?
2. Point/Show me e.g. 90
3. Use different starting numbers e.g. 10-20, 36-46
4. Count in 4s (4x tables)
5. Show me 37p. How much more to make 50p? £1 etc.

Higher Level Combining

$31 + 3 = ?$

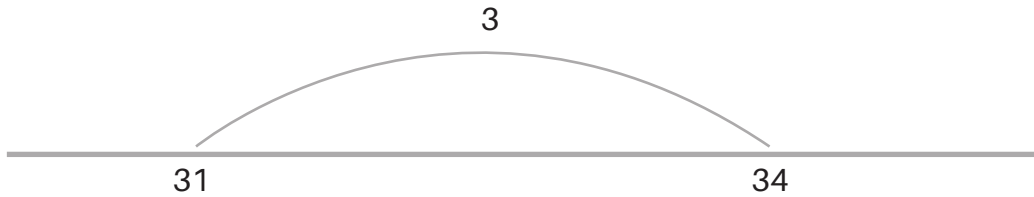
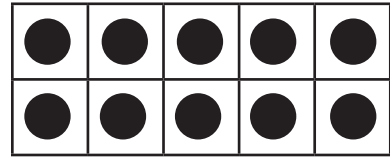
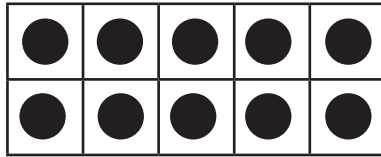
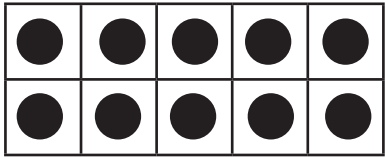

$24 + \square = 29$

Display, then screen

Display, then screen

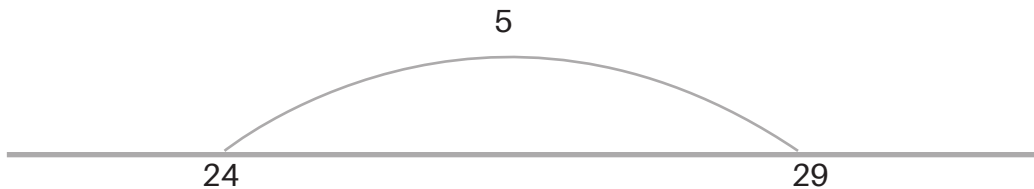

Combining 2 single-digit numbers

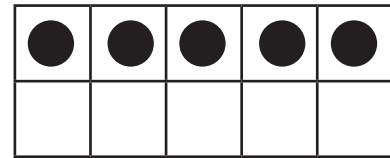
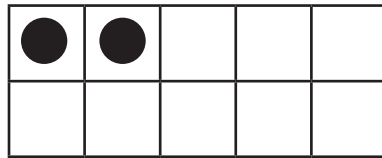
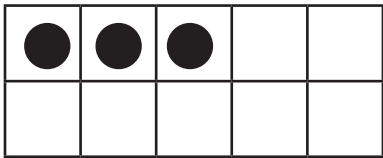

Higher Level Partitioning

Example 1

$7 + 5 = ?$

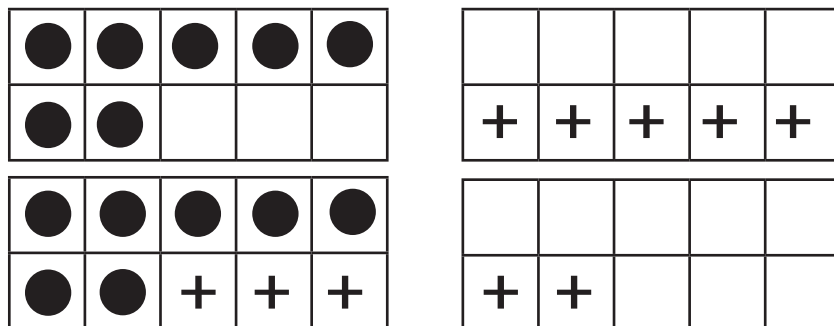

$7 + 5 = 12$

$7 + 3 + 2 = 12$

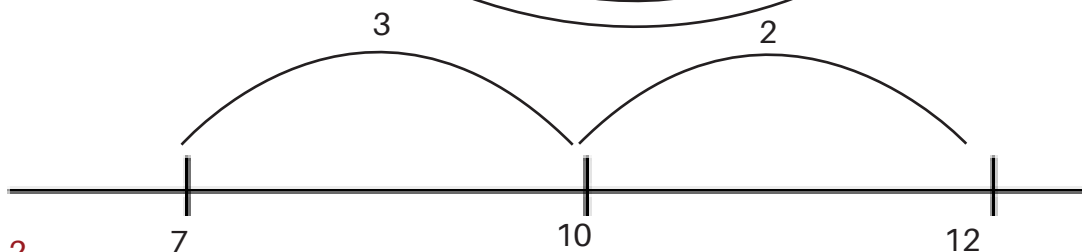

Example 2

$37 + 5 = ?$

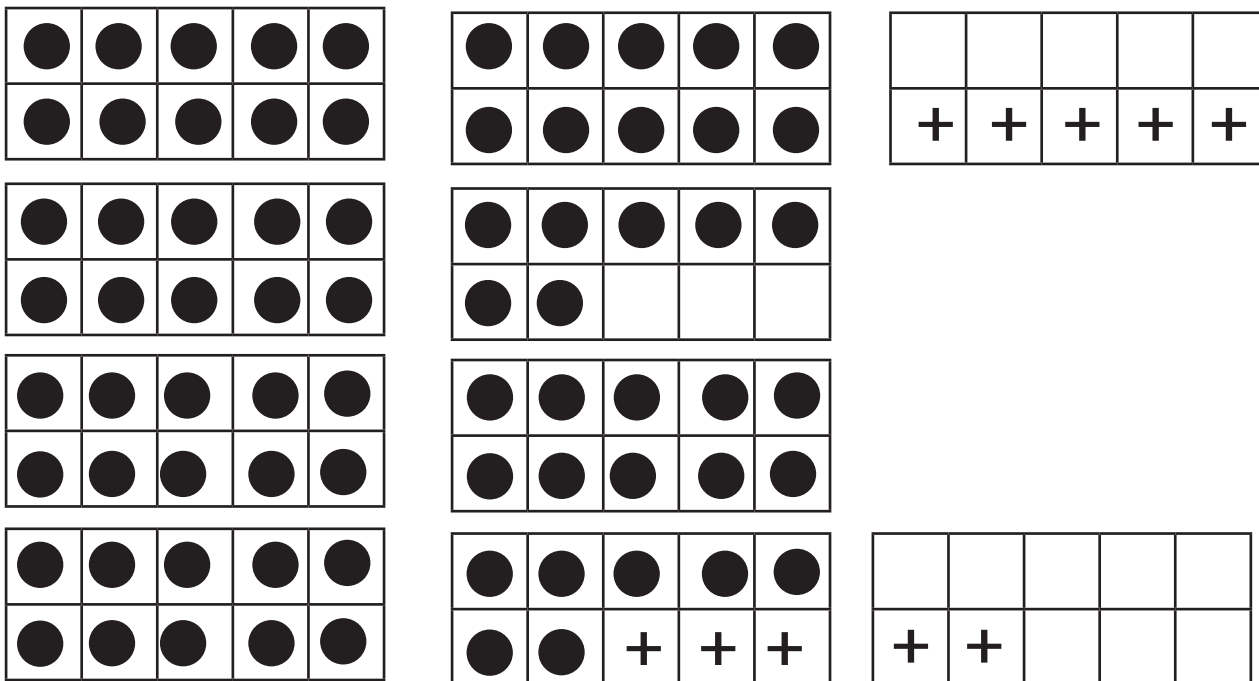

$37 + 5 = 42$

$37 + 3 + 2 = 42$

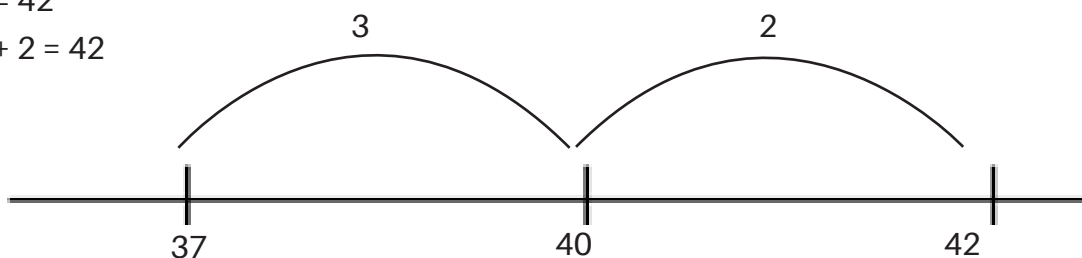

Rounding and Adjusting Strategy

Sometimes it is easier to adjust when adding or subtracting numbers. This is often the 'forgotten' strategy.

All you need to do is draw an empty number line.

1. Adding 'near 10' to a number

Example 1

$$16 + 9 = 25$$

$$16 + 10 - 1 = 25$$

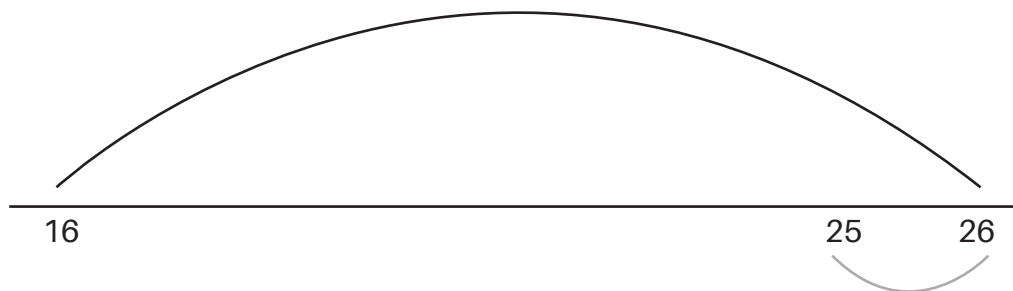

Example 2

$$29 + 8 = 37$$

$$29 + 10 - 2 = 37$$

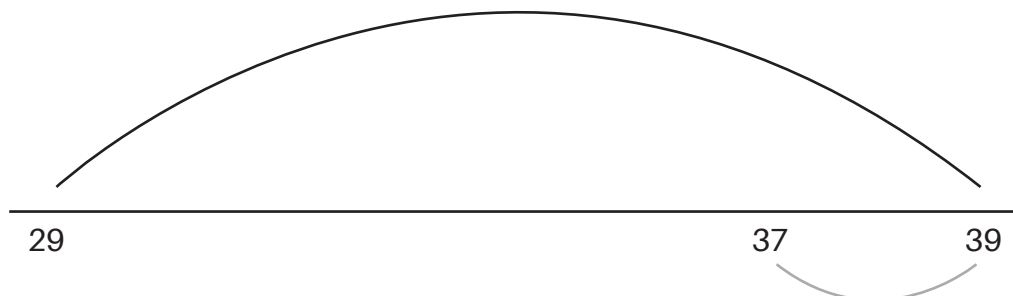

Example 3

$$88 + 7 = 95$$

$$88 + 10 - 3 = 95$$

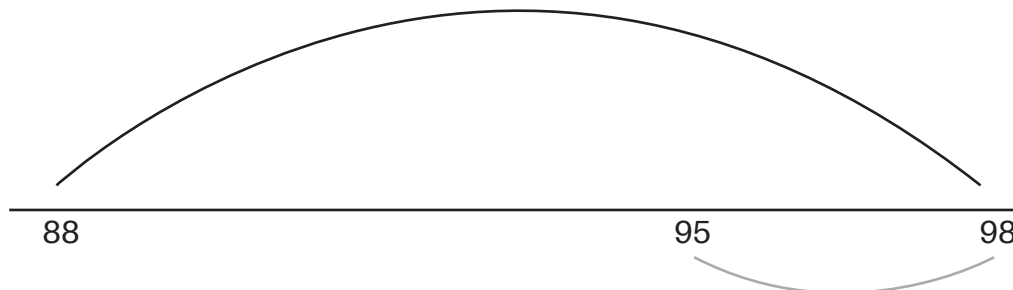

Rounding and Adjusting Strategy

1. Subtracting to a 'near 10' from a number

Example 1

$$34 - 9 = 25$$

$$34 - 10 + 1 = 25$$

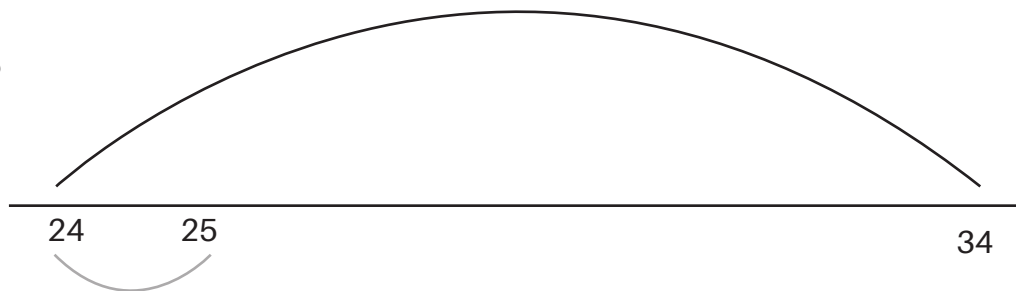

Example 2

$$71 - 7 = 64$$

$$71 - 10 + 3 = 64$$

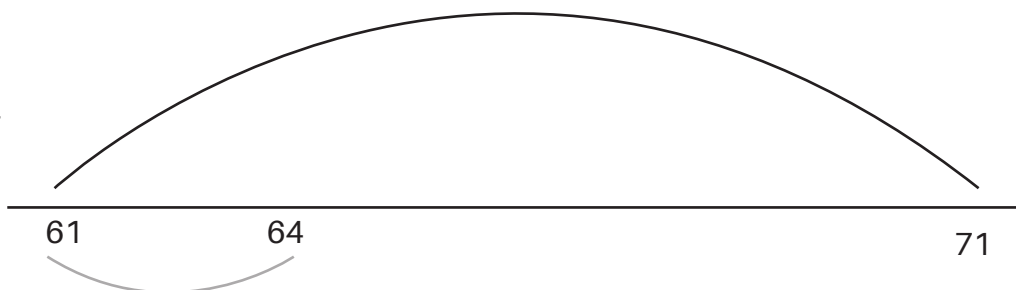

Example 3

$$105 - 8 = 97$$

$$105 - 10 + 2 = 97$$

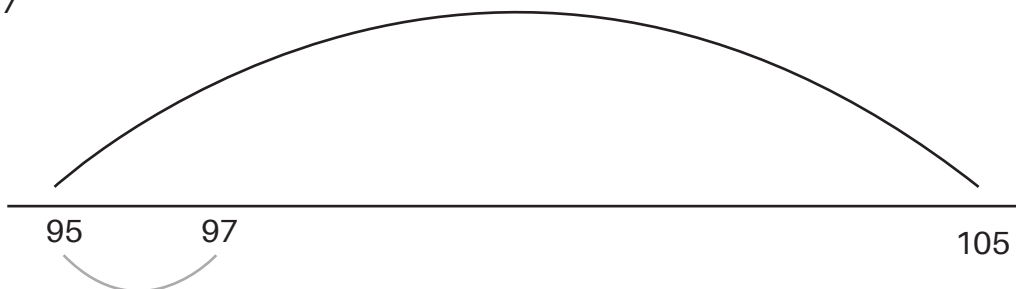

Rounding and Adjusting Strategy

1. Adding to a 'near multiple of 10'

Example 1

$$43 + 29 = 72$$

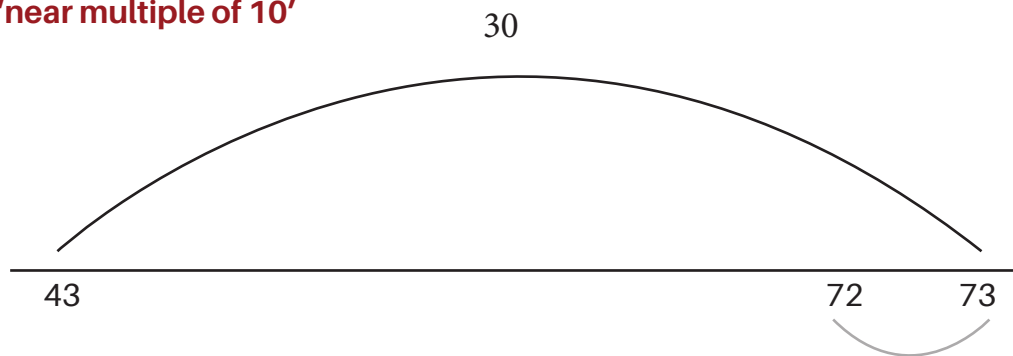

Example 2

$$55 + 37 = 92$$

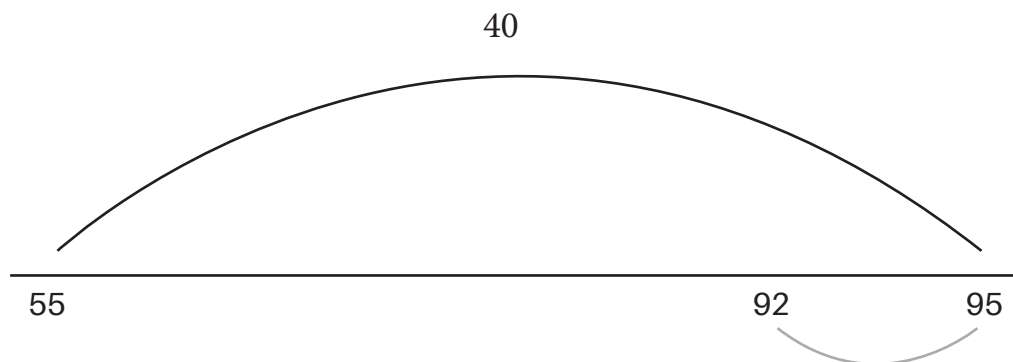

2. Subtracting to a 'near multiple of 10'

Example 1

$$94 - 19 = 75$$

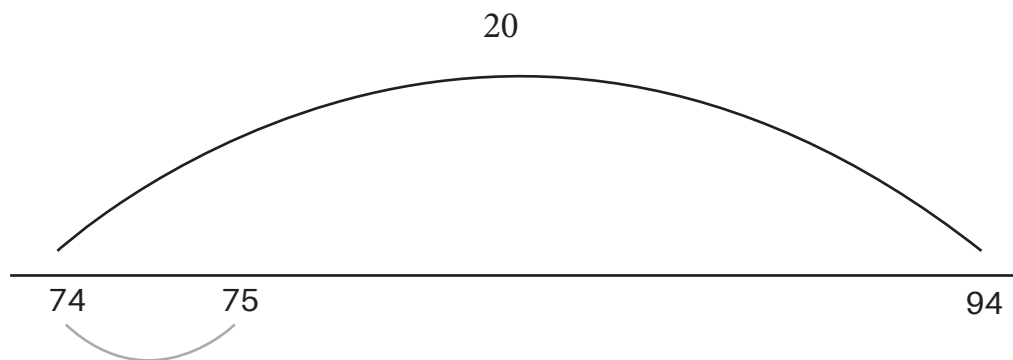

Example 2

$$87 - 38 = 49$$

$$87 - 40 + 2 = 49$$

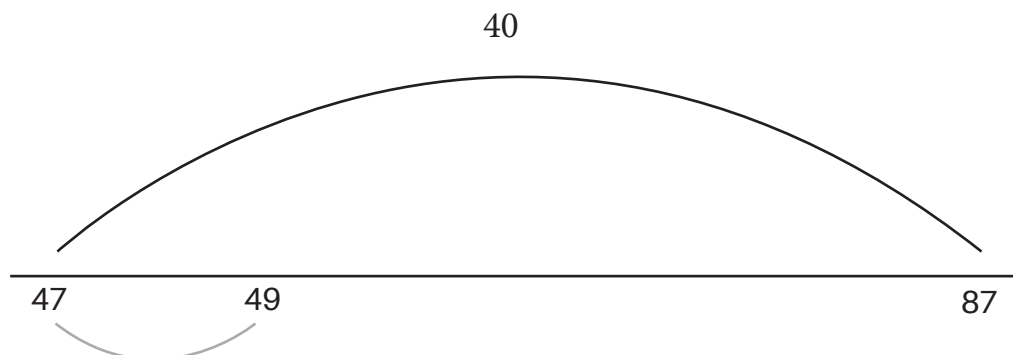

Which Strategy is Best?

When pupils have worked through a variety of mental strategies e.g;

- Counting on/back
- Rounding/adjusting
- Combining
- Partitioning etc.

They can use the most efficient/practical one (or very often the one they feel most comfortable with). This final example shows a variety of ways to do the same problem mentally.

Problem:

For his break, Charlie buys a banana at 36p and a bottle of water at 48p. How much does he owe the shop?

Method 1

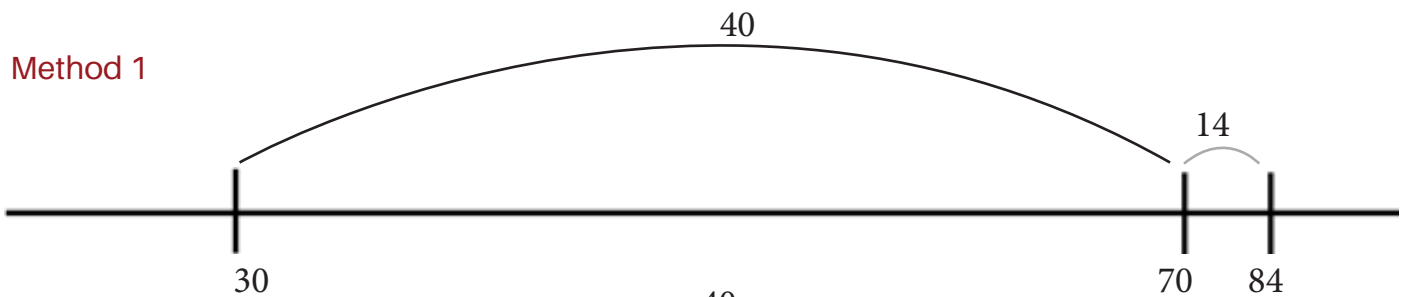

Method 2

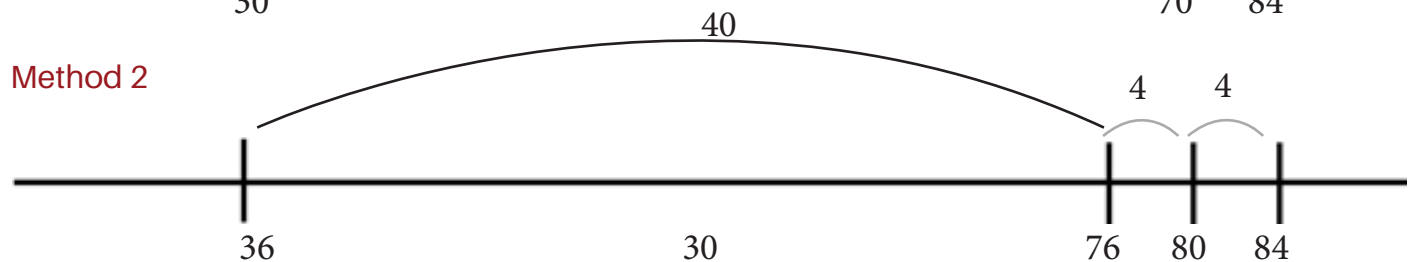

Method 3

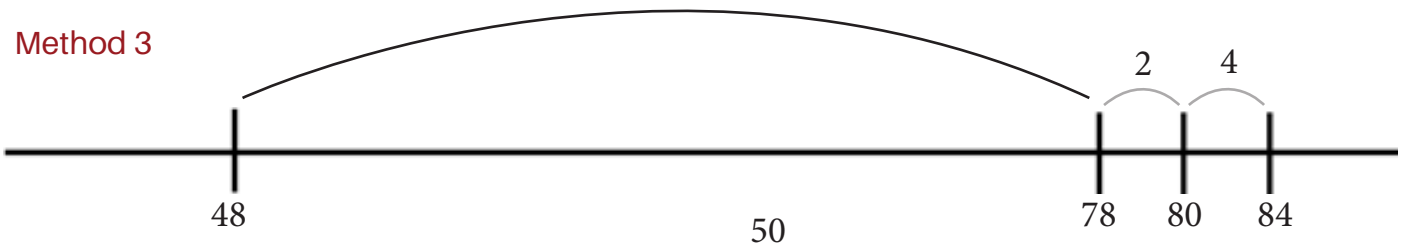

Method 4

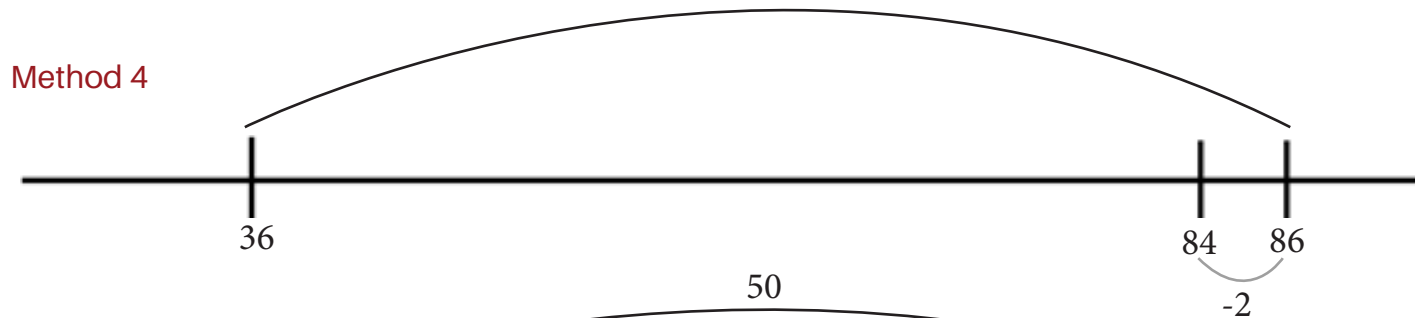

Method 5

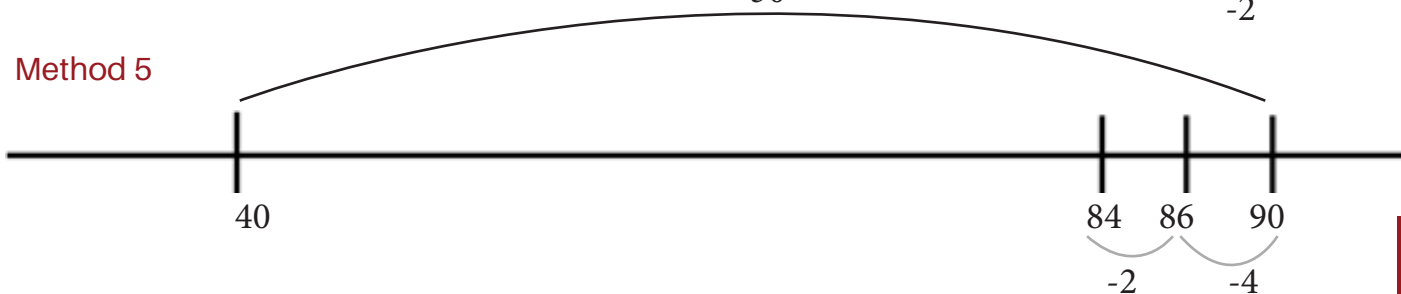

Subtraction

Things I Need for Subtraction

Materials:

- Place Value Kit or Page 6 of KS1 Booklet (Laminated)

Useful Websites:

<http://enlvm.usu.edu/>

- Click on 'Browse Resources'
- Click on 'NLVM Activities'
- Number and Operations
- PreK2
- Base Blocks - Subtraction

<http://www.topmarksmaths.co.uk>

- Whiteboard Resources - Maths
- KS1 - Addition/Subtraction
- Base Block Subtraction
- Spinners

Subtracting Within 20

a) Get your child to answer any subtraction (taking away) number facts within 20.

E.g. 11-7, 13-5, 15-9, 19-7, 15-5 etc.

b) Get them to draw the sum on an Empty Number Line (ENL).

Example 1: 11-7

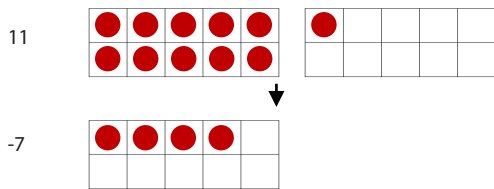
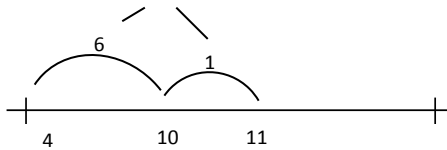

Example 2: 15-9

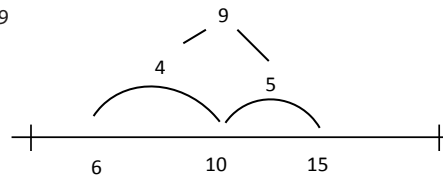

OR

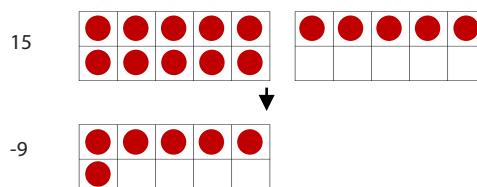
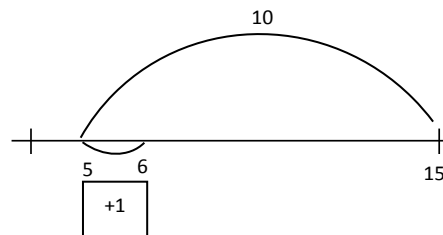

Tip: Try to make sure your child is not counting back in 1s.

Subtraction

Subtract to a Ten

- a) Get your child to make up any 2 digit number the like. E.g. 63 using the Place Value Kit or Page 6 of KS1 Booklet (Laminated).
- b) Ask them: What is the last decade number (Ten)? **Answer: 60** - How many did you need to subtract (take away) to get to that Ten? **Answer: 3**
- c) Ask your child to draw this out using an Empty Number Line.

E.g. 1: 63-3

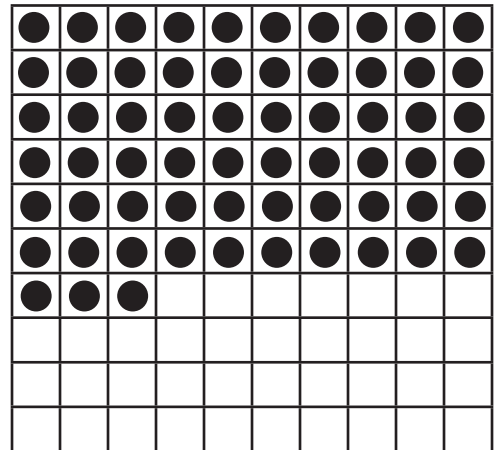
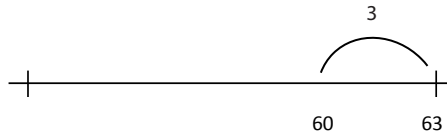

E.g. 2: 28 - 8

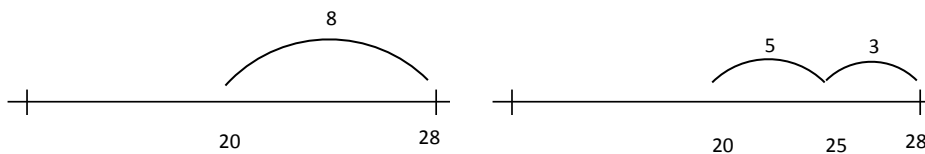

- d) Give them plenty of practice with different 2 digit numbers

E.g.

- 87 to 80
- 41 to 40
- 34 to 30
- 92 to 90
- 59 to 50
- 76 to 70

Subtraction

Subtract from a Ten

a) Ask your child to put out some multiples of 10 (20, 30, 40, 50, 60, 70, 80,90) e.g. 30 using the **Place Value Kit or Page 6 of KS1 Booklet (Laminated)**

b) Get them to put dots on each square of the last 10.

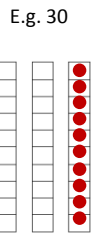

c) Then ask them to choose any number they want from 1-10 e.g. 6

d) Ask them to remove 6 dots from their last 10 strip and tell you what is left i.e. 2 Tens 4 Units & 24.

e) Get your child to show you this on an Empty Number Line (ENL).

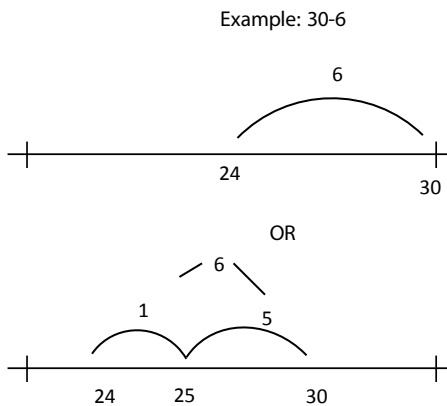

f) Repeat this using different examples each time.

E.g. 60-4, 90-8, 20-1, 40-7 etc.

Subtraction

Subtracting Multiples of Ten

- a) Ask your child to make any 2 digit number they want with the Place Value Kit or Page 6 of KS1 Booklet (Laminated) e.g. 53.

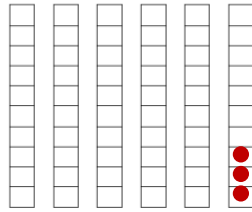

- b) Get them to show this on an ENL

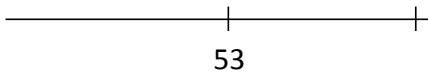

- c) You suggest a suitable multiple of 10 to take away from this e.g. 30 (10, 20, 30...).
- d) Ask your child to take away this number.
- e) How many are left?

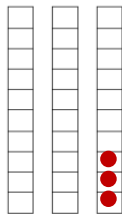

Tip: Make sure they are removing Ten Strips.

Subtracting T/U

a) Ask your child to set out the digit number 2 Tens 4 Units or 24 using their Place Value Kit on Post It labels using T(Tens) and U(Units).

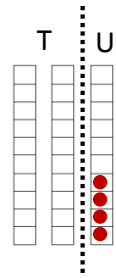

b) From your digit cards using a "Post It" label 3 in the Units and "Post It" label 1 in the Tens (see (c)).

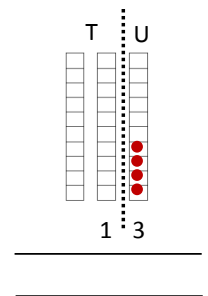

c) Ask your child to start with Units and say 4-3 (Top takeaway bottom) (rub out 3 dots) leaves 1. Then go to the Tens and ask your child to say 2 Tens - 1 Ten (top take away bottom) leaves 1 ten. **Answer = 11.**

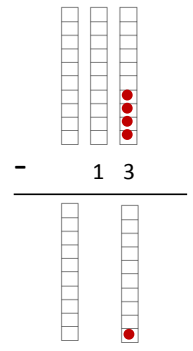

d) Get your child to do this sum using an ENL. E.g.

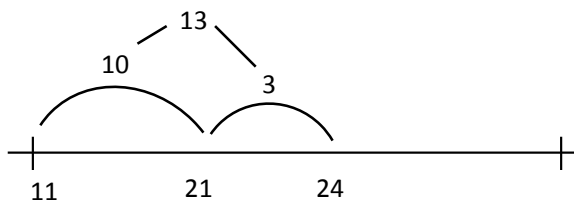

e) Repeat 5a,b, c for other subtraction sums like the one above.

Subtracting T/U

a) Ask your child to set the number 35 out using their Place Value Kit or Page 6 of KS1 Booklet (Laminated) and "Post It" labels using T(Tens) and U(Units).

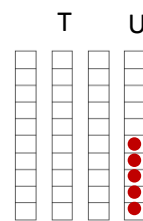

b) From your digit cards using a "Post It" label 6 in the Units and "Post It" label 1 in the Tens.

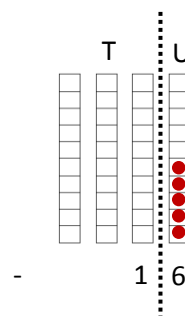

c) Ask your child why this is slightly more difficult? (Because in Units column 5-6 I cannot do).

d) Get your child to show 35 a different way using a different number of T/U. (Like the word done in Place Value Cards).

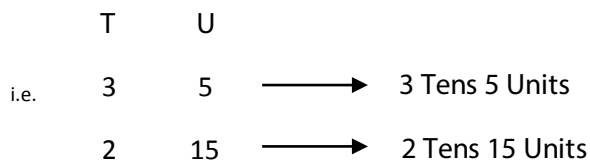

e) Now with the sum looking like this;

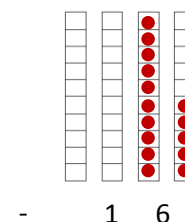

f) Ask your child to start with Units 15-6 (remove or rub out 6 dots from 15 dots leaving 9 Units. Then 2 Tens - 1 Ten = 1 Ten. Answer=19.

g) Get your child to show the sum using ENL.

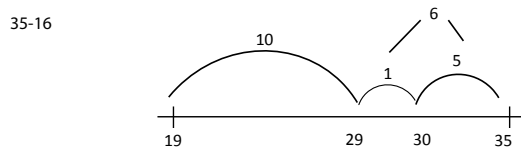

OR

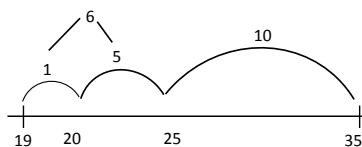

OR

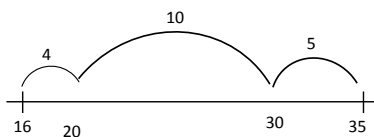

- Mark 16 on ENL
- Mark 35 on ENL
- Count on from 16 to next 10 (2) = 4
- Count on from 20 to 30 = 10
- Count on from 30 to 35 = 5
- Add 4 + 10 + 5 = 19

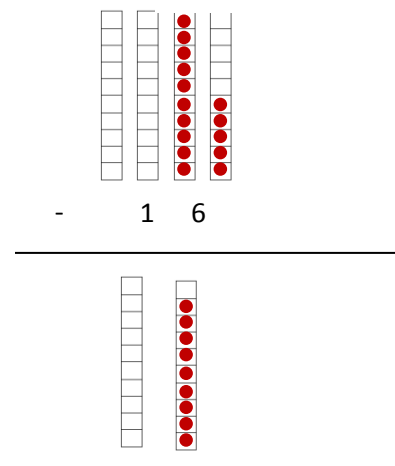

h) Go to ENLVM - Browse Resources - NVLM Activities - Number and Operations - PreK 2 - Base Blocks Subtraction. Give your child practice in subtracting TU-TU. If you need to exchange a Ten - Click on it and drag it into Units column and note what happens. Then drag the Red Units onto the Blue Units to take away.

Tip 1: Make sure your child checks the answer by drawing it out on an ENL.

Tip 2: Always ask your child to give you a rough answer (approximate) before they start.

Tip 3: Hopefully through time your child shouldn't need the practical materials.

Subtracting H/T/U

a) What about e.g.

$$\begin{array}{r} 100 \\ - 16 \\ \hline \\ \hline \end{array}$$

b) Get your child to take out 100 square from the Place Value Kit or Page 6 of KS1 Booklet (Laminated).

c) Change 100 Squares into 10 Ten Strips

$$\begin{array}{r} \text{H T U} = \text{T U} \\ 100 \quad 10:0 \end{array}$$

d) Then change a Ten Strip into 10 Units

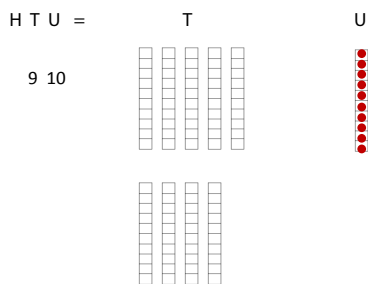

e) Now the sum should look like this;

$$\begin{array}{r} \text{H} \quad \text{T} \quad \text{U} \\ 0 \quad 9 \quad 10 \\ - \quad 1 \quad 6 \\ \hline \quad 8 \quad 4 \\ \hline \end{array}$$

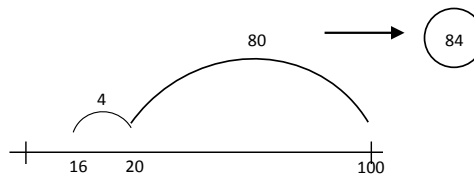

f) Still get your child to do it mentally;

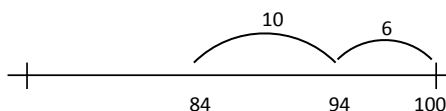

OR

Subtracting Money

- a) Where numbers are close together or easier to count on, encourage your child to do this. Doing it as a sum will take a lot longer.

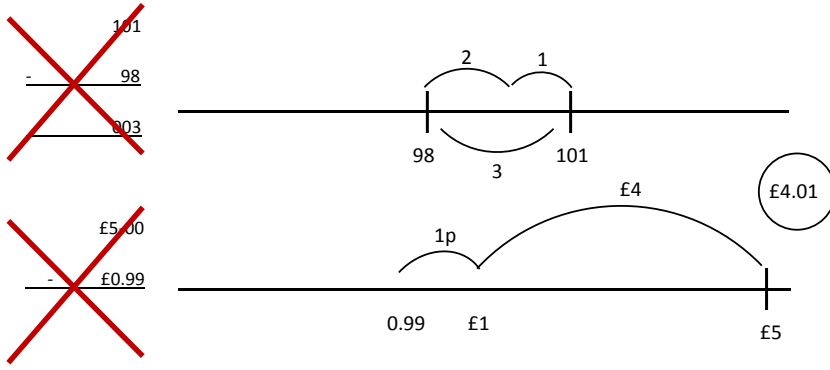

Addition

Things I Need for Addition

Materials:

- Place Value Kit or Page 6 of KS1 Booklet (Laminated)

Useful Websites:

<http://enlvm.usu.edu/>

- Click on 'Browse Resources'
- Click on 'NLVM Activities'
- Number and Operations
- PreK2
- Addition

<http://www.topmarks.co.uk/>

- Whiteboard Resources - Maths - KS1
- Addition of 2/3 digit numbers
- 100 Hunt plus 10
- Bingo Addition
- Dartboard Addition
- Spinners

Adding to a Ten

a) Get your child to make up any 2 digit number they wish e.g. 58 using the Place Value Kit or Page 6 of the KS1 Booklet (Laminated)

b) Ask them: What is the next decade (Ten)? **Answer: 60** - Ask the child: How many more to get to next decade? **Answer: 2**

c) Draw it out using an **Empty Number Line (ENL)** - see below

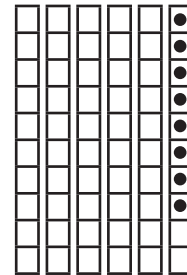
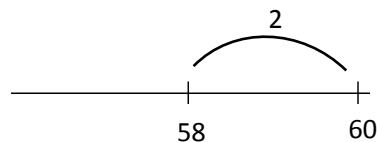

E.g. 2. 22. What is the next decade? (30). How many more to get 30? **Answer: 8.**

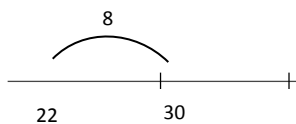

d) Give them plenty of practice with different numbers. **e.g.**

- 45 to 50
- 22 - 30
- 64 - 70
- 39 - 40
- 71 - 80
- 93 - 100
- 87 - 90

Addition

Adding from a Ten

a) Get your child to put out some multiples of 10 (10, 20, 30, 40, 50, 60, 70, 80, 90) within 100 using the **Place Value Kit or Page 6 (KS1 Booklet Laminated)**

b) You pick a number between 1-10 and ask them to add (+) it on using another Ten Strip and the marker.

E.g. $30 + 4 = 34$

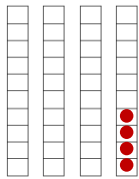

c) Ask them to show you this on an **ENL**.

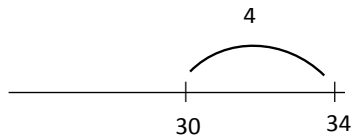

d) Repeat this using different examples each time; (using Place Value Kit and Empty Number Line)

E.g. $40+7$, $90+3$ etc

Adding Multiples of Ten

a) Ask your child to make up any 2 digit number with the **Place Value Kit** or Page 7 KS1 Booklet (Laminated) e.g. 48.

b) Show this on an **ENL** please.

c) You suggest multiples of 10 to add to it e.g. (10, 20, 30, 40...).

d) Your child puts these out and tells you how many is there altogether.

E.g. $48+40$

e) Show using an ENL.

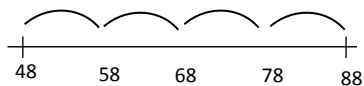

48

OR

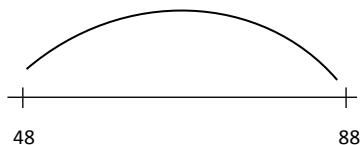

f) Google oswegomaths. Go to resource - [oswego.org/games Ghostblaster](http://oswego.org/games/Ghostblaster) (Multiple).

Addition

Adding Tens/Units

Go to Google NLVM - Browse Resources - NLVM Activities - Number and Operations - PreK2 - Base Blocks Addition.

a) Give your child practice in adding TU/TU

b) If the Units are more than 10 when added you can click a rectangle around 10 and drag it over to Tens column and drop it in e.g.

T	U
3	8
4 ₁	6
8	4

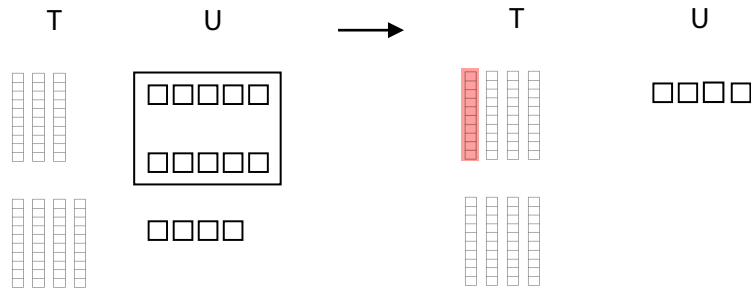

c) Get your child to show this using ENL.

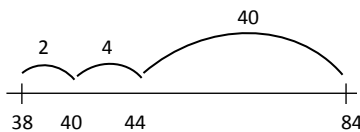

d) Give your child practice using sums of your own set out like this;

	T	U	(Roughly)
	5	7	(60)
+	3	8	(40)
	9	5	100

E.g.

Tip: Start with units. $7 + 8 = 15$. Keep your 5 Units and bring the Ten over 5 Tens + 3 Tens + 1Ten = 9 Tens

Always do a rough sum e.g. $57 + 38$ is nearly $60 + 40 = 100$.

Place Value

Things I Need for Place Value

Materials:

- Place Value Kit OR
- Page 6 (KS1 Booklet)

Useful Websites:

<http://nlvm.usu.edu/>

- Google NLVM
- Click on 'Browse Resources'
- Click on 'NLVM Activities'
- Number and Operations
- PreK2
- Base Blocks

<http://www.topmarks.co.uk/>

- Whiteboard Resources - Maths
- KS1 - Place Value
- DIENES and Coins
- Place Value Charts
- 'Group the Blocks and Identify'

i Go to website address: <http://nlvm.usu.edu/> or Google NVLM

- a. Number and Operations - PreK2
- b. Base Blocks

a) Give your child plenty of practice making up 2 digit numbers (Tens/Units) e.g. 37, 43, 72 etc. using the laminated version of Page 6 (Blank 100 Square) or Place Value Kit or Page 6 of KS1 Booklet (Laminated).

Tip: Encourage the child to draw a line between T/U e.g. 37 is 3 Tens Strips and 7 Dots with dry wipe marker on a 4th Strip (see below diagram).

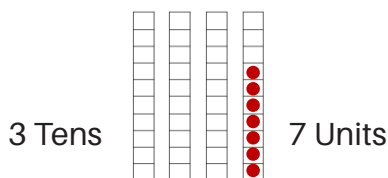

b) Encourage the child to do the same with 'real' money e.g. 10ps and 1ps - 37p = x3 10ps and x7 1ps



Place Value

c)  Google NLVM (Base Block) and get your child to show you e.g. 37 a different way (using a different number of T/U). Look at the answer below.

E.g. **T** **U** 37 is 3 Tens 7 Units
 3 7

T **U** 37 is 2 Tens 17 Units
 2 17

d) Give your child the chance to practise some of these with their Place Value Strips (Page 6 of KS1 Booklet or Place Value Kit)

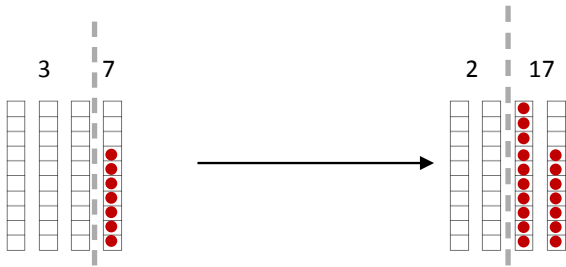

e) Now try this using 10ps/1ps



f) Get your child to make 100 (use 3 columns) then move 100 square over to Tens column.

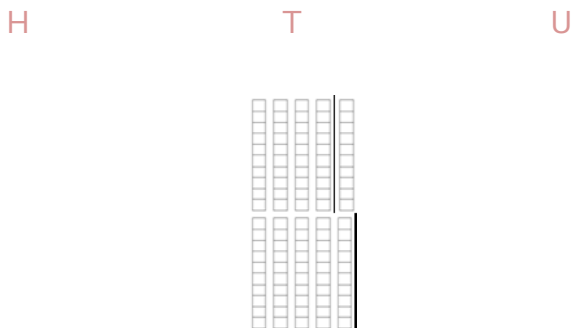

g).Ask What Happens?

h) How many tens?

Place Value

i). Get your child to move one of the Tens into Units columns. What happens? How many Tens (9) and how many units (10)?

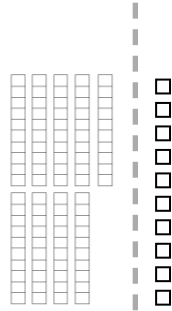

100 = 9 Tens, 10 Units

j). Get your child to show you 10 strips of 10 (Page 6 of KS1 Booklet or Place Value Kit).

k). Get your child to do the same using with the laminate of Page 6 of KS1 Booklet using a dry wipe marker to fill in Units e.g. 100 = 9 Tens 10 Units.

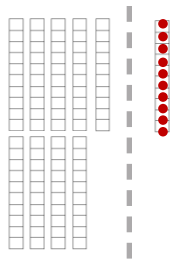

l). Now do the same with money i.e. £1 = (10 x 10p) or (9 x 10p) + (10 + 1p)



OR



Useful Websites/Links

Website Address	Details
http://nlvm.usu.edu/en/nav/vlibrary.html	Go to PreK2 Base Blocks Base Blocks Addition Base Blocks Subtraction
www.topmarks.co.uk	Go to Whiteboard Resources Go to Maths KS1 - loads of activities in all areas of maths OR Go to Parents Resources
www.clounagh.org	
www.ictgames.com	
www.mathsisfun.co.uk	
www.counton.org	
www.mad4maths.com	

Games

- Jigsaws (number)
- Interactive jigsaws in Topmarks
- Go to - Parents
- Go to - Maths Games
- Playing Cards
- Money Games
- Ludo
- Snakes/Ladders
- Connect 4
- Dominoes
- Draughts
- Simple Sudoku

Helping out at Home

Out and About

- Plan your trip around the shops
- Recognising new coins 20p, 50p, £1, £2
- Change from 10p, 20p, 50p, £1 - adding/subtracting
- Exchanging coins for least amount
- Sequence shopping from lightest to heaviest



In the Kitchen

- Read analogue/digital clock
- Sharing out dinner (e.g. pizzas etc)/fractions
- Reading scales on kettle, weighing scales -working out how much to fill, get to 1kg etc
- Non uniform measuring - Baking: how many spoonfuls of flour weigh 100g etc.



Around the House

- Talk about different shapes, squares, rectangles, triangles, circles etc.
- Estimate lengths, widths, heights etc.
- Fractions - half an apple, kit kat, sandwich etc.

